

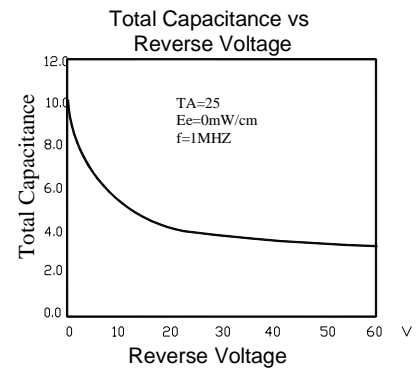

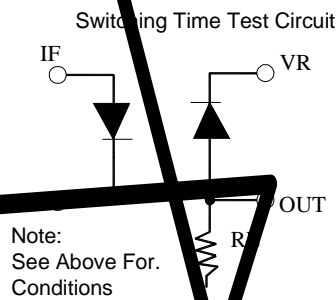

## Typical Electrical / Optical Characteristics Curves (25 Ambient Temperature Unless Otherwise Noted)

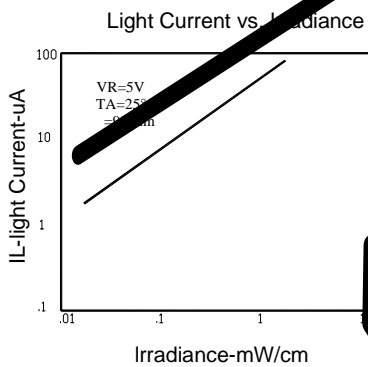
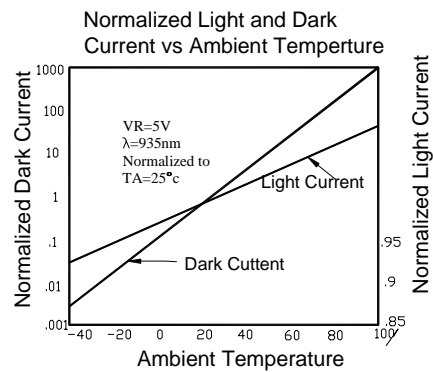
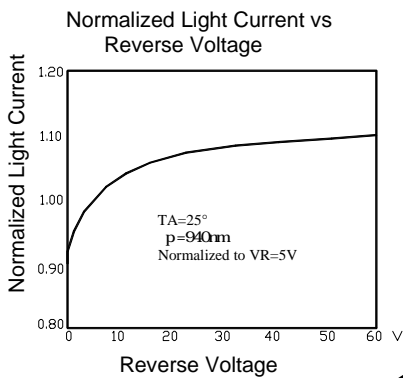
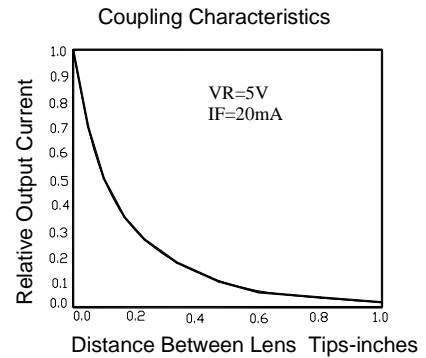
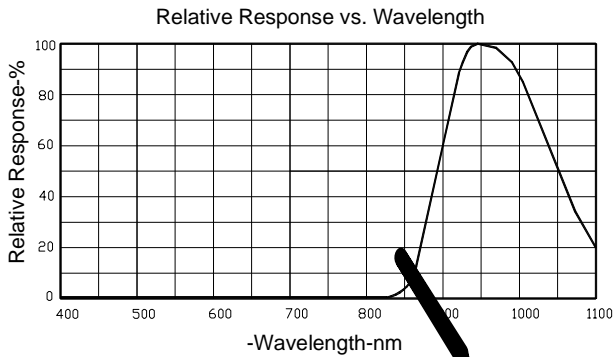

### Sensitivity Diagram

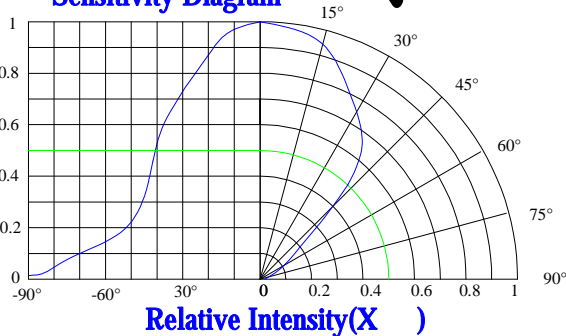

### Sensitivity Diagram

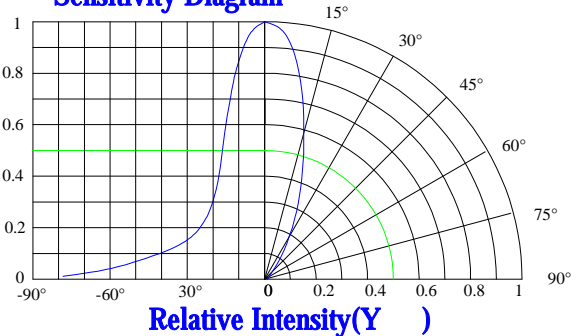

## Infrared Photo Diode Specification

-



## Label Explanation

LIGHT Universal Label

Customer Defined Label



## Carrier Tape Specifications (Loaded Quantity: 2300pcs/reel)

ITEM	W	A0	A1	B0	B1	K0	E	F	D0	D1	P0	P1	P2	T
DI M	12.00	4.35	2.05	4.40	4.10	3.65	1.75	5.50	1.50	1.60	4.00	8.00	2.00	0.30
TOL	+0.10 -0.10	+0.10 -0.10	+0.10 -0.10	+0.10 -0.10	+0.10 -0.10	+0.10 -0.10	+0.10 -0.10	+0.10 -0.10	+0.10 -0.10	+0.10 -0.10	+0.10 -0.10	+0.10 -0.10	+0.10 -0.10	+0.05 -0.05

