

Features

- ◆ Pb free product RoHS compliant Pb ROHS
- ◆ High Photo Sensitivity
- ◆ General purpose leads
- ◆ Reliable and rugged
- ◆ Long life solid state reliability

Package Dimension

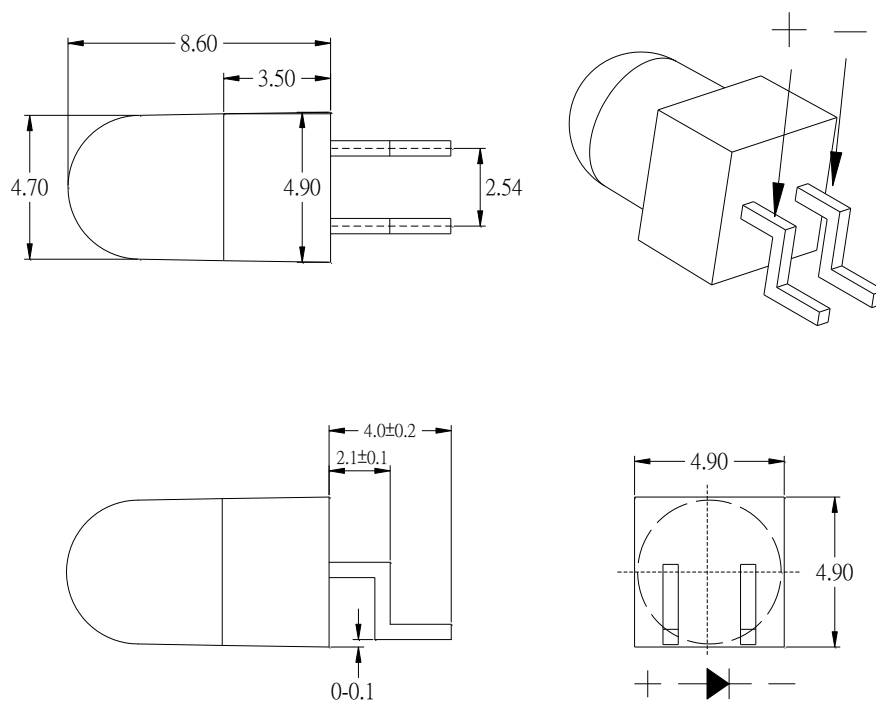

Part NO.	Chip Material	Lens Color
LG-05PD4D94K-557C-B-T	Silicon	Black

Notes:

1. All dimensions are in millimeters.
2. Tolerance is ± 0.20 mm unless otherwise noted.
 ± 0.2 .

Typical Electrical / Optical Characteristics Curves (25 Ambient Temperature Unless Otherwise Noted)

Coupling Characteristics

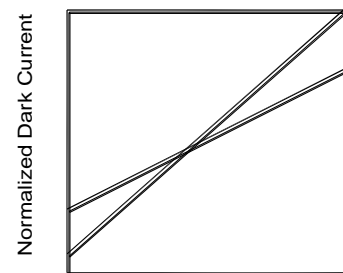
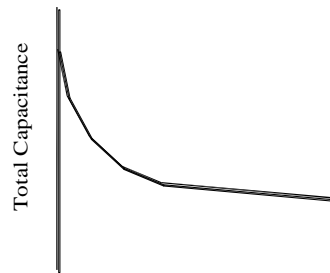
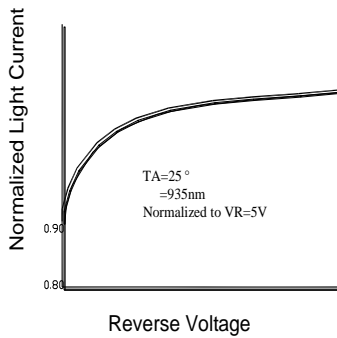
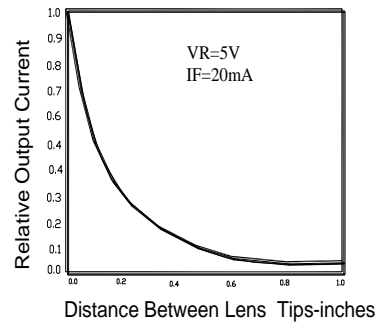

Light Current vs. Irradiance

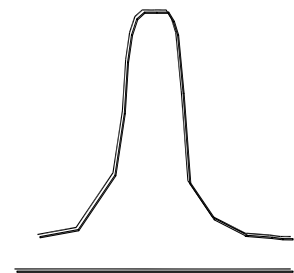
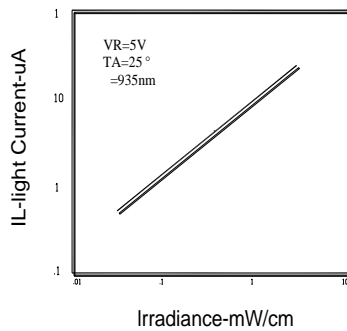

PACKAGE

1. Package Dimensions

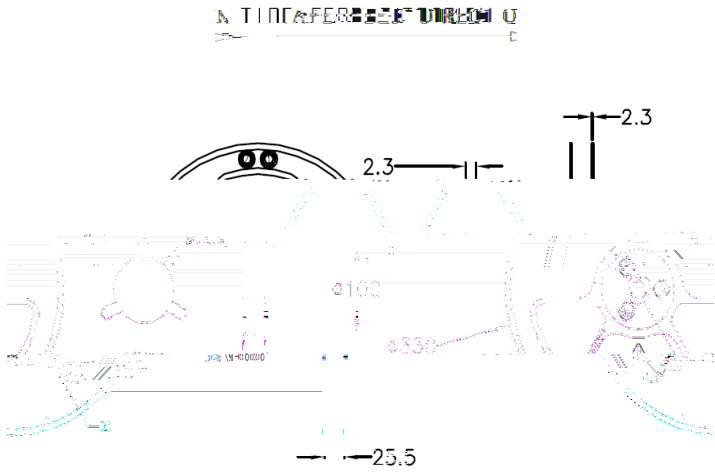
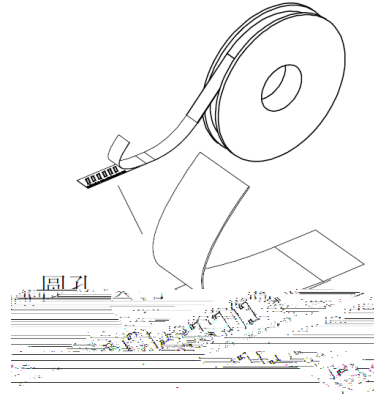
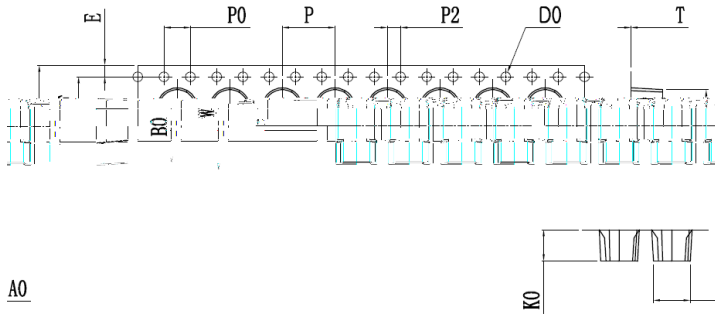

Item	Specification	
	Minum	Maximum
W	15.97	16.3
P	7.9	8.1
E	1.65	1.85
F	7.4	7.6
D	1.5	1.6
P0	3.9	4.1
P0x10	39.8	40.2
P2	1.9	2.1
A0	5.2	5.4
B0	10.6	10.8
K0	4.8	5.0

Notes:

1. All dimensions in millimeters.
2. All dimensions meet EIA-481-C requirements.
3. Component area by a heat-sealing manufacturer.

- 1.
2. EIA-481-C
- 3.

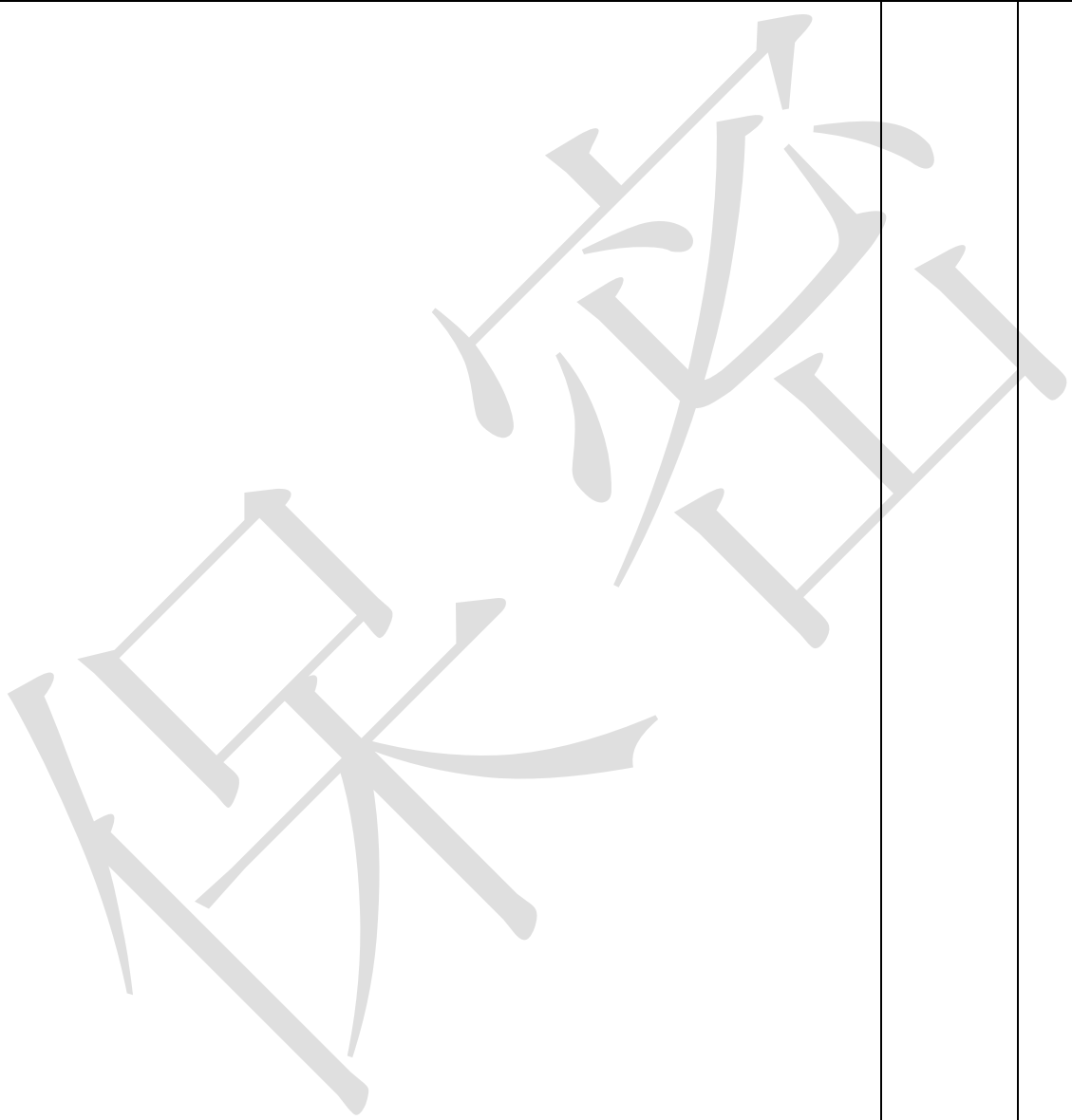
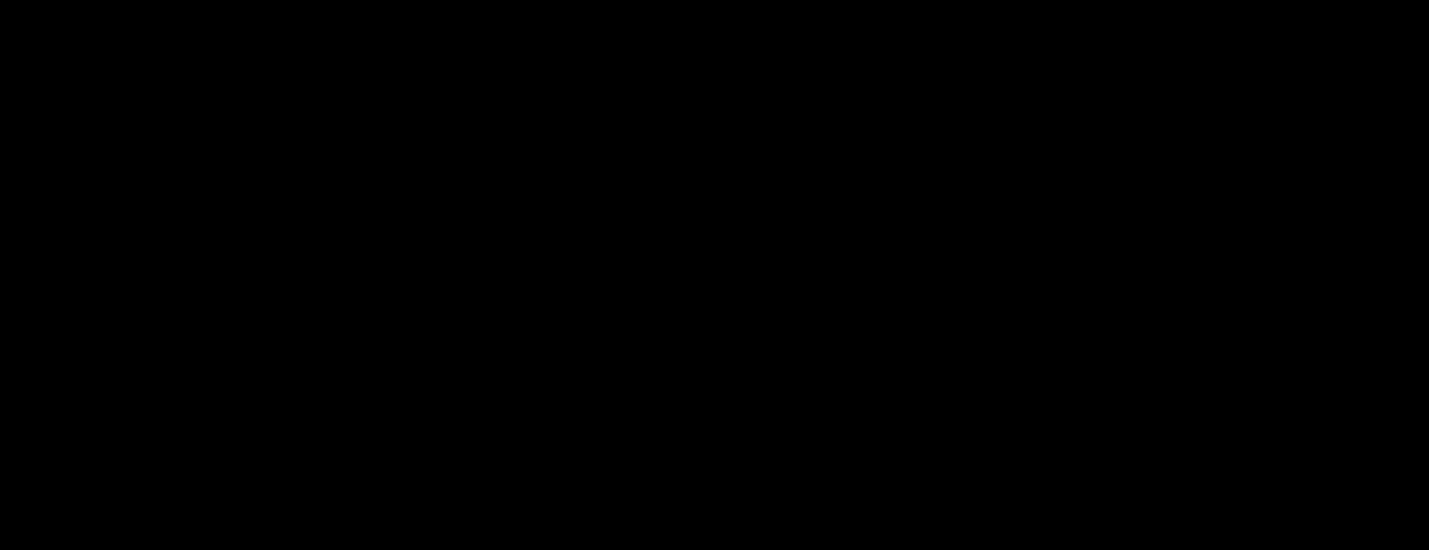

1